

LENS BERLIN

CHARAKTERISTIK:

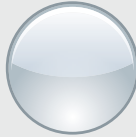

Wide Angle



Polished



PMMA

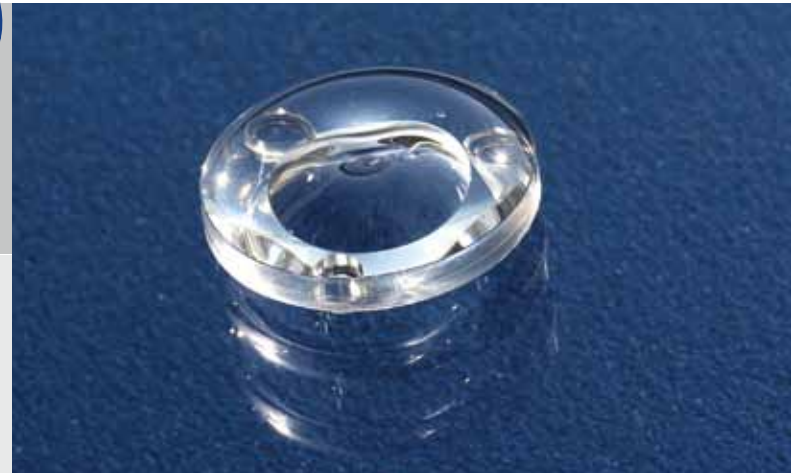

LENS BERLIN

Artikel-Nr.:	L051-XP-700
Typ:	Wide Angle Lens
Diameter:	26.0 mm
Höhe:	7.9 mm
Charakteristik:	Wide Angle
Oberfläche:	Polished
Max. Winkel:	± 75°
Effizienz theoretisch:	77 %
Material:	PMMA

Alle Angaben / Maße sind Circa-Angaben und unverbindlich, technische Änderungen vorbehalten.
Unverbindliche Labormesswerte bezogen auf eine Referenz LED.

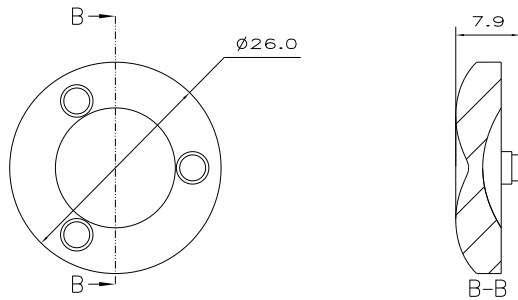

- » Zerstreulinse mit homogener Beleuchtung im Winkelbereich von 0° bis 70°
- » Drei Montagebeinchen für die Fixierung auf der Platine

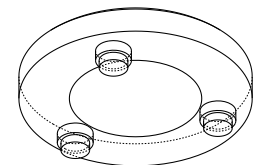
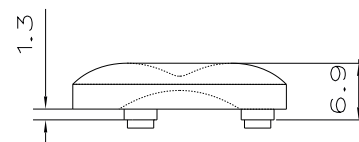
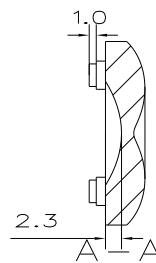
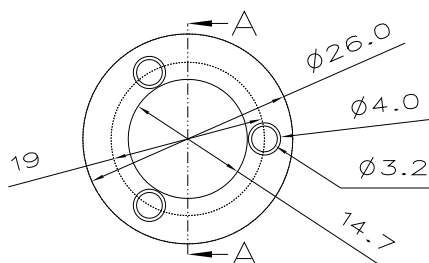

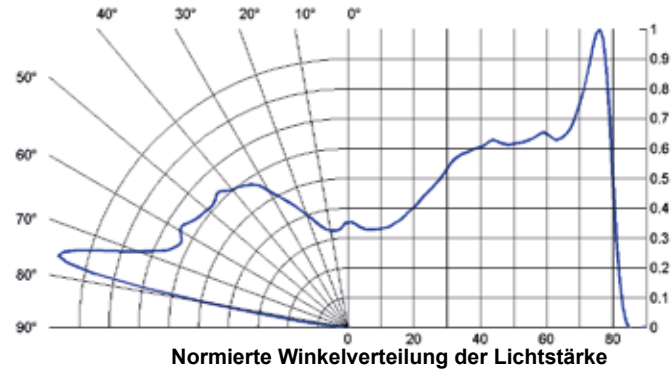
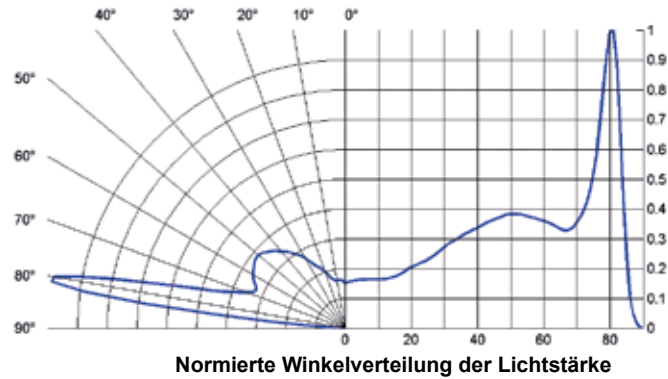
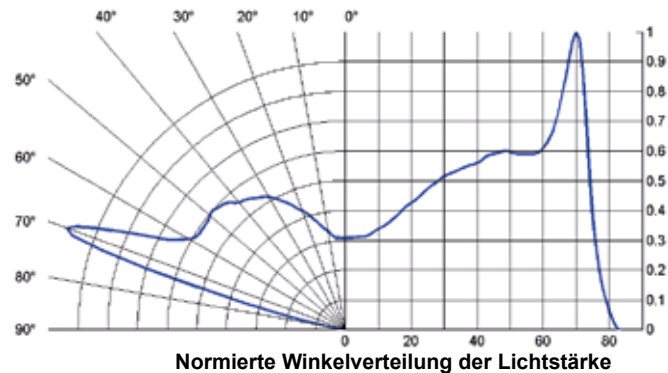
LED:
**CREE
XM-L**

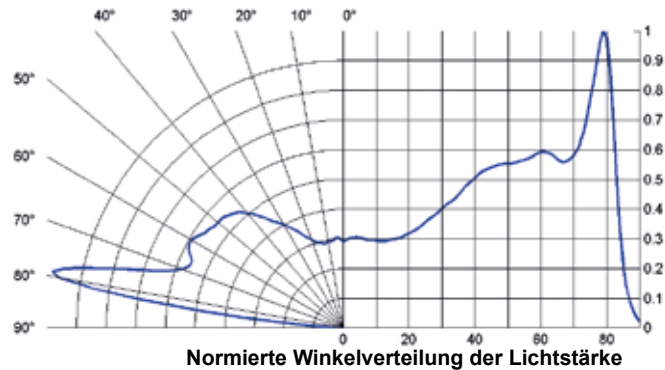
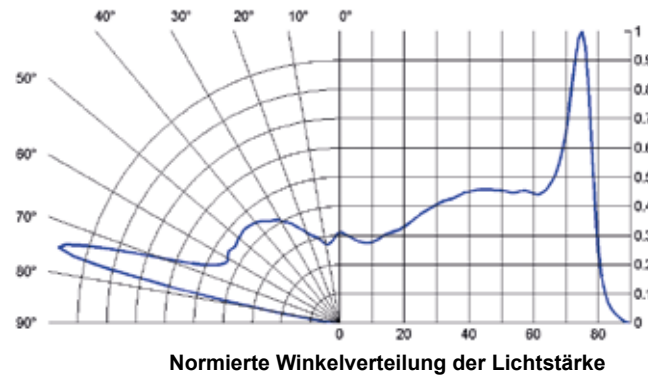
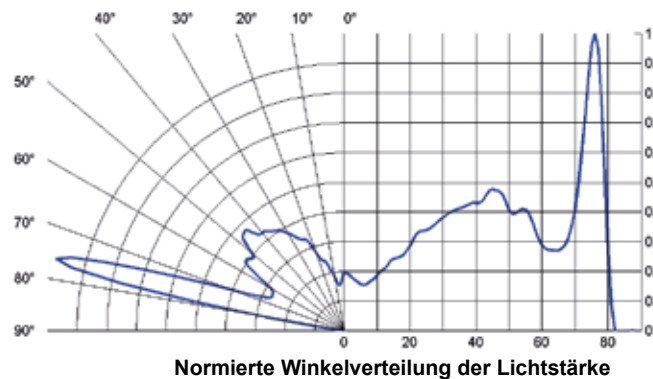
LED:
**CREE
XP-E**

LED:
**OSRAM
Oslon square**

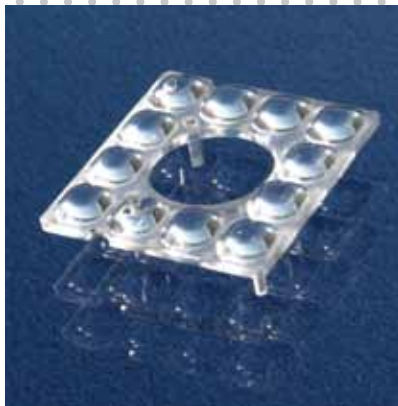
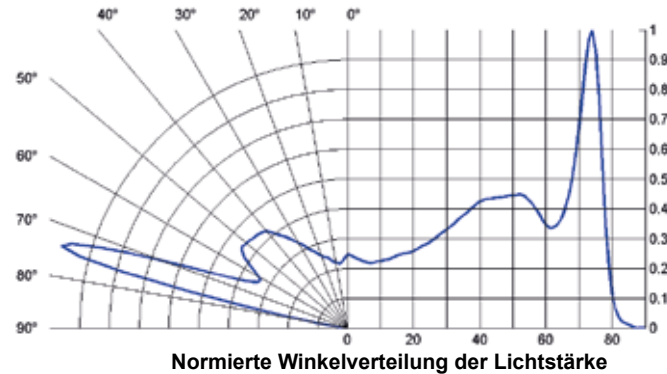
LED:
PHILIPS
Luxeon R

LED:
PHILIPS
Luxeon T

LED:
SAMSUNG
3535

LED:

**SEOUL
Z5**

**Im Standardsortiment nicht
das Passende dabei?**



Fragen Sie uns doch einfach
Tel. +49 (0) 78 43 99 511 - 0
Wir freuen uns auf Ihren Anruf!